



## INTRODUCTION

Congratulations and thank you for purchasing the RS GEN3 Brushless/Brushed Sensored Electronic Speed Control (ESC). Carrying on the Tekin tradition of providing high performance, top quality electronics, the RS GEN3 sets a new benchmark in precision racing equipment. Based on the award-winning, internationally popular RS series speed control, the GEN3 brings next level performance to your race machine.

## BEFORE YOU BEGIN

Read through this manual and familiarize yourself with the terms, error codes and general workings of the ESC. Keep this manual for future reference.

- 1) The RS GEN3 is intended only for 1/10th scale and smaller vehicles that weigh under 4lbs ready to run.
- 2) Make sure the motor/battery are within Tekin specs.
- 3) Check battery polarity! **NO** Reverse Polarity Protection.
- 4) Check labeling of solder posts before soldering.
- 5) Locate the power capacitor and note that it **MUST** be installed or warranty will be void. Section 3.
- 6) Use in or around water can damage the ESC and void the warranty.

## SPECIFICATIONS

Controls - RS GEN3/SPEC	Fwd/Brk or Fwd/Brk/Rev
<b>Input Voltage</b> - RS GEN3 RS SPEC	4-9 NiCd/NiMH (2-3S LiPo) 4-7 NiCd/NiMH (2S LiPo)
<b>Motor Limits</b> - RS GEN3	
Brushless (2S)	8.5Turn, 36mm Can
Brushless (3S)	10.5Turn, 36mm Can
Brushed (2S)	12Turn 540 Size
Brushed (3S)	20Turn 540 Size
RS SPEC	
Brushless (2S)	13.5T, 36mm Can
Brushed (2S)	20T 540 Size
<b>Max Current</b>	
RS GEN3	120Amps
RS SPEC	60Amps
<b>Programmable BEC</b>	
RS GEN3	6V-7.4V / 5.5Amp
RS SPEC	6.0V / 3.7Amp
<b>Dimensions</b>	
<b>Weight</b>	1.0 x 1.3 x 0.51" / 25.4 x 33 x 12.9 mm .85oz / 24g

**WARNING:** Exceeding product specifications or using equipment outside of the specification ranges above automatically voids the 180-day manufacturer warranty. Any damage caused from misuse or use of equipment outside of the specifications will be subject to servicing and or replacement fees to be determined by the Tekin Service Department. For further warranty information, please refer to Section 22 or visit us on the web at [www.teamtekin.com](http://www.teamtekin.com).

## POWER CAPACITOR

**CAUTION:** A power capacitor is supplied with the RS GEN3 Series (TT3520) and **MUST BE MOUNTED** on the ESC for proper operation (Fig. 1). Failure to use the power capacitor can cause irreparable damage to the ESC.

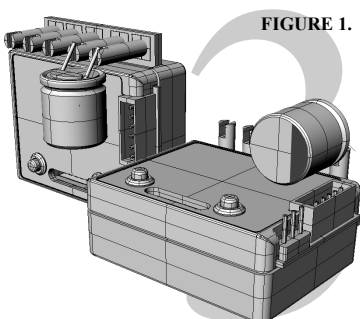

**FIGURE 1. INSTALLING CAP:**  
The capacitor should be mounted directly to the Battery Positive BATT (+) and Battery Negative BATT (-) posts on the ESC, with the capacitor wires cut as short as possible. The capacitor polarity is indicated on the top of the capacitor by a colored half-circle which is the BATT (-) connection (Fig. 2).

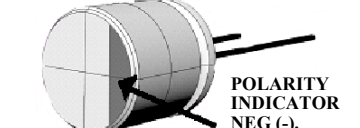

**FIGURE 2.**

## INSTALLATION

### Plan Speed Control Placement

- 1) Choose a location for the ESC that is protected from debris and moving parts. Plan ahead with wire routing and try to keep the motor leads about the same length. Motor leads should be short, but not tight. Leave some slack in the wiring to account for chassis flex and vibrations while driving.
- 2) Mock up your wire lengths for your planned ESC placement. It is recommended to solder the power cap and all leads to the ESC before mounting to the chassis.
- 3) Choose a wiring method for the motor and battery leads. Direct wiring uses no plugs and provides the best connection between the motor and the ESC. You can use Tekin 4.0mm Hi-Power bullet connectors (TT3054) for easy motor removal. Battery connector choice is up to you, use the female plug on the battery and the male on the ESC and double check the polarity.
- 4) To mount the ESC, clean the bottom with rubbing alcohol. NEVER use any chemicals such as motor spray or acetone as they will damage the plastic. Use the provided double sided tape or a 3M adhesive tape.
- 5) Secure the ON/OFF switch in a safe, accessible place away from moving parts and debris.

## QUICKSTART

After properly installing your ESC, follow these steps for a quick setup:

- 1) With the ESC installed and properly wired, (Figs. 4, 5 & 6) connect the battery.
- 2) Turn the transmitter on FIRST, then the ESC.
- 3) Take note any codes that may be present. Refer to Section 8 for codes.
- 4) Set transmitter throttle trims to 0 and throttle EPAs to 100. You can access these features in the system menu on the transmitter.
- 5) Perform a Radio Calibration, refer to Sections 9 & 10.
- 6) Factory default voltage cutoff is set for a 2S LiPo battery @ 6.4V. Double check the battery you are using and adjust Voltage Cutoff if needed.
- 7) Updating Firmware via HotWire:

You can connect to the RS GEN3 through the Fan/Data port or through the receiver wire. Hotwire 3.0 connects directly to the Data Port for both Bluetooth and USB programming. HotWire 2.0 connects to the Data Port with the included harness or through the receiver plug for USB programming.



## SOLDERING

Brushless wiring instructions refer to Fig. 4  
Brushed, refer to Figs. 5 & 6.

### Tips & Tricks

Placing the ESC in a vise (gently) provides a stable work area to do a quality job (Figure 3). The order for proper soldering is:

- ◆ Tin Posts
- ◆ Tin Wires
- ◆ Heat Posts
- ◆ Heat Wires
- ◆ Heat both and connect

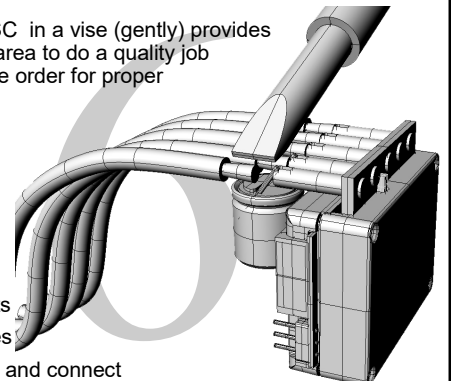

**FIGURE 3.**

*Hint:* If the wire is too hot to hold 2" away from the solder joint, the iron has been on for too long— stop, let everything cool and try again. Excessive heat can damage the ESC.

## WIRING INSTRUCTIONS

1) **CONNECT ESC TO RECEIVER**  
Plug the ESC into the throttle (TH) channel of the receiver.

- ◆ Channel 1: Servo
- ◆ Channel 2: ESC

"REMEMBER: 1 to Turn, 2 to Burn"

2) **CONNECT ESC TO BATTERY**  
Visually verify that the connector on the battery pack and the ESC match.

**DO NOT CONNECT BATTERY INCORRECTLY TO ESC, VERIFY THAT THE BATTERY POSITIVE WIRE WILL CONNECT TO THE ESC POSITIVE WIRE BEFORE CONNECTING!**

3) **CONNECT ESC TO MOTOR**  
First, determine the type of motor you are using. **SENSORLESS** motors require the sensor harness, **SENSORLESS** motors do not. Refer to Figures 4, 5 and 6 for wiring brushless and brushed motors.

## IMPORTANT LED CODES

Your ESC is an intelligent piece of equipment and can usually tell you exactly what the problem is. Refer to this section should your ESC show you any LED sequence out of the ordinary. You can also go to [www.teamtekin.com/esc\\_codes.html](http://www.teamtekin.com/esc_codes.html) to see these codes in action. Each code will FLASH rapidly:

<b>ALL LEDS FLASHING</b>	No signal from receiver. Check that receiver bind light is on and ESC is plugged into CH2.
<b>LEDS 1, 2, 6 &amp; 7</b>	Wrong motor type, or internal short in ESC or motor detected. Check motor wire solder joints.
<b>LEDS 1, 2 &amp; 3</b>	LOW neutral signal. Adjust radio trims to center and perform radio calibration.
<b>LEDS 5, 6 &amp; 7</b>	HIGH neutral signal. Adjust radio trims to center and perform radio calibration.
<b>LEDS 1, 3 &amp; 5</b>	LOW VOLTAGE CUTOFF. Battery voltage is below programmed voltage cutoff. Charge battery.
<b>LEDS 3 &amp; 5</b>	Spec Mode activated. Sensored-Only, no Timing or Boost. ROAR Legal.
<b>LEDS 3, 4 &amp; 5</b>	Big Event Spec Lockout mode activated. Can only be undone via HotWire™. ROAR Legal.

## BRUSHLESS MOTOR WIRING DIAGRAM

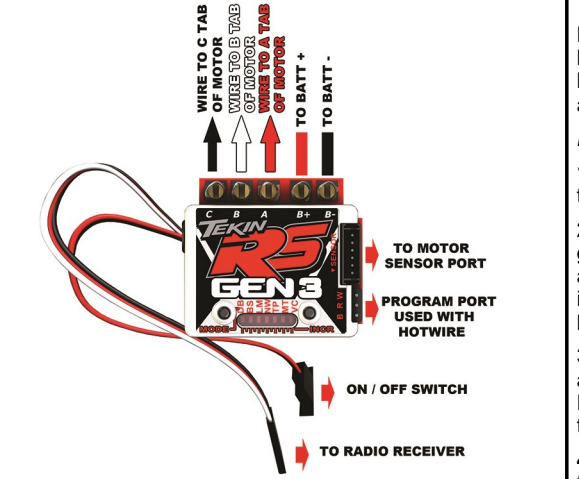

**FIGURE 4.**

**MOTOR TYPE (MT) SETTINGS**  
MT1 / LED 1 - FWD/BRK  
MT2 / LED 2 - FWD/REV IMMEDIATE  
MT3 / LED 3 - FWD/BRK/REV DELAY

## BRUSHED MOTOR WIRING DIAGRAM

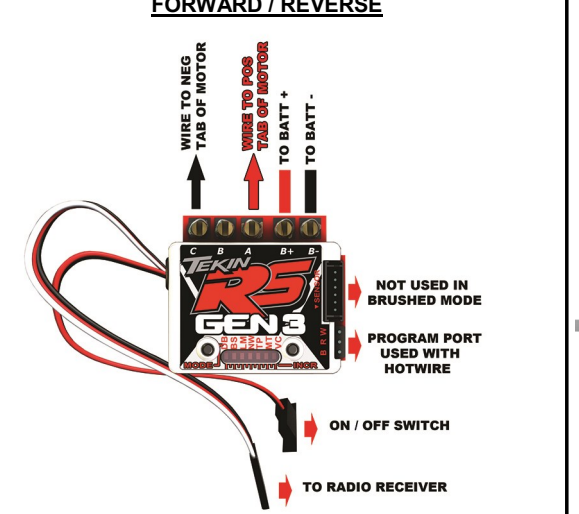

**FIGURE 5.**

**MOTOR TYPE (MT) SETTINGS**  
MT5 / LED 5 - FWD/REV IMMEDIATE  
MT6 / LED 6 - FWD/BRK/REV DELAY

## FORWARD ONLY

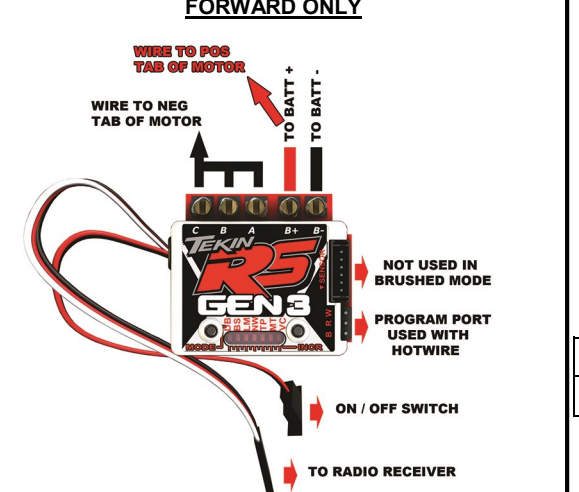

**FIGURE 6.**

**MOTOR TYPE (MT) SETTINGS**  
MT4 / LED 4 - FWD/BRK

## RADIO CALIBRATION

**NOTE:** Before Radio Calibrating, ensure the ESC is hooked up to the receiver in Channel 2 (CH2), a charged battery is properly connected, and the transmitter is turned on and bound to your receiver.

Refer to Section 10 below.

- 1) On your transmitter, set all trim adjustments to the middle, throttle/brake EPAs and Dual Rate set to 100.
- 2) Press and hold MODE for 3-5 seconds or until the ESC gives a 4 chime confirmation. It is now in calibration mode and will start by looking for the neutral signal first, while blinking the center (#4) LED with a simultaneous "beep" with each blink.
- 3) Once neutral is found, the 4 chime confirmation will sound again and the right (#7) LED will begin to blink, indicating the ESC is looking for a full throttle signal. Pull and hold full throttle until you hear the confirmation chime.
- 4) The ESC will then switch to the left (#1) LED and look for a full brake/reverse signal. Push and hold full brake until you hear the confirmation chime. After the confirmation, let go of the trigger and the ESC will arm, go to neutral and actively show the onboard temperature (Section 11).
- 5) If the ESC does not show the temperature monitor ( LED 4 and cycling back and forth) check section 8 to see if any Error Codes are present.

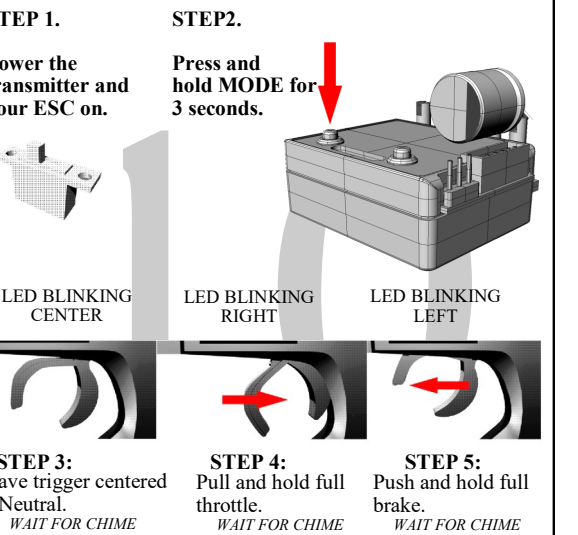

*Hint:* If the ESC fails to recognize your full throttle signal, try reversing the throttle channel in the transmitter system menu.

## TEMPERATURE MONITOR

The On-Board Temperature Monitor works to provide you with important feedback on ESC temperature, helping you to adjust gearing and avoid long term heat damage. To use:

- 1) The ESC must be calibrated to your transmitter and must be in neutral.
- 2) The middle LED will be on steady then blink out every 2 seconds. \*Blinky mode will show LEDs 3 & 5 blinking rapidly in neutral and Locked Spec Mode will show LEDs 3, 4 & 5 blinking rapidly.\*
- 3) At the moment that the center LED blinks out, one or more of the other LEDs will light up.
- 4) LED Temperature readings:

LED1	LED1-2	LED1-3	LED1-4	LED1-5	LED1-6	LED1-7
Ambient	120°F	140°F	160°F	180°F	200°F	220°F

Should your ESC show all 7 LEDs, stop driving and let it cool. The ESC will go into Thermal Shutdown if it is not allowed to cool down. You may need to lower your gearing, lower your Boost settings, change to a higher turn motor or repair any binding in the drivetrain. Continuous use at high temperatures and multiple "thermals" can damage the ESC.



## QUICKTUNE™

### PRESS MODE TO ACCESS:

LED1 - DRAG BRAKE  
LED2 - BRAKE STRENGTH  
LED3 - TORQUE CONTROL  
LED4 - NEUTRAL WIDTH  
LED5 - TIMING PROFILES  
LED6 - MOTOR TYPE  
LED7 - VOLTAGE CUTOFF

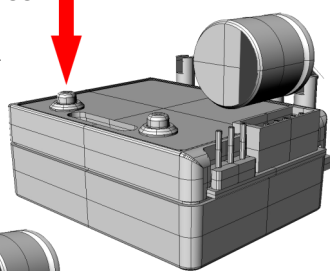

### PRESS INCR TO:

Adjust the feature currently selected. Refer to the QuickTune adjustments table below (section 13) for ranges of adjustment and what they accomplish.

**LED1: DRAG BRAKE** provides immediate braking action in neutral. This gently slows the car down when you let off the trigger. Higher values increase the drag brake strength.

**LED2 (BRUSHLESS MODE): REV/BRAKE STRENGTH** adjusts your maximum brake strength and reverse speed when in brushless mode. Higher values increase brake strength and increase reverse speed.

**LED2 (BRUSHED MODE): PUSH CONTROL or ANTI-DRAG** overcomes the natural drag of a brushed motor when throttle returns to neutral. Low values give you a short duration push, higher values a longer duration push.

**LED3: TORQUE CONTROL** adjusts the initial power delivered to the motor under acceleration. Low values will decrease the initial power and give a softer feel to the throttle. The highest value (13) gives full power to the motor, no limiter is in effect. Ex: Current Limiter at 80 gives 80% power.

**LED4: NEUTRAL WIDTH** adjusts the dead band around neutral. A low neutral width value will provide more precise and quick trigger sensitivity around neutral. Higher values decrease trigger sensitivity.

**LED5: TIMING PROFILES** are pre-programmed with 5 preset profiles and 2 Custom profiles. Setting 1-5 will put the speed control in Sensored Only mode and apply the preset amount of timing.

TP1: Spec Stock "blinky mode" 0\*timing boost  
TP2: 15\* Timing Boost / RPM Range 5443-20,016  
TP3: 25\* Timing Boost / RPM Range 5443-20,016  
TP4: 35\* Timing Boost / RPM Range 5443-20,016  
TP5: 45\* Timing Boost / RPM Range 5443-20,016

\*RPM Ranges are divided in half when running in 1S LiPo Mode\*

### LED6: MOTOR TYPE

- 1) Brushless, Fwd/Brk (LED1 ON)
- 2) Brushless, Fwd/Immediate Rev (LED1-LED2 ON)
- 3) Brushless, Fwd/Brk/Rev Delay (LED1-LED3 ON)
- 4) Brushed, Fwd/Brk (LED1-LED4 ON)
- 5) Brushed, Fwd/Brk/Rev (LED1-LED5 ON)
- 6) Brushed, Fwd/Brk/Rev Delay (LED1-LED6 ON)

### LED7: VOLTAGE CUTOFF

**IMPORTANT:** If using LiPo batteries, ensure a proper Voltage Cutoff is programmed.

- 1) 3.2 Volts (LED1 ON). NiCd/NiMh
- 2) 6.4 Volts (LED1-LED2 ON). 2S LiPo
- 3) 9.6 Volts (LED1-LED3 ON). 3S LiPo

**LED Display:** The LED light bar displays values and settings on your speed control in a few ways. Settings with a range of 1-7 are shown by just one LED at a time. Settings with a wider range of 1-13 are shown by a combination of 1 and 2 LEDs at the same time. While adjusting, the LEDs will "walk" up the ladder in a way that 1 will be lit, followed by 1&2, then 2, then 2&3 and so on. Critical settings (such as Motor Type and Voltage Cutoff) are always indicated by multiple LEDs at a time to ensure proper adjustment.

## QUICKTUNE™ SETTINGS

MODE	RANGE	DEFAULT
<b>DRAG BRAKE (DB)</b>	1-13	2 (10%)
<b>BRAKE (BS) —</b> Brushless Mode Only	1-13	13 (MAX)
<b>PUSH CONTROL (PC) —</b> Brushed Mode Only	1-13	1 (Off)
<b>TORQUE CONTROL (TC)</b>	1-7	7 (No Limiter)
<b>NEUTRAL WIDTH (NW)</b>	1-13	2&3
<b>TIMING PROFILE (TP)</b>	1-7	1 (Spec Mode)
<b>MOTOR TYPE (MT)</b>	1-6	3 (Brushless)
<b>VOLTAGE CUTOFF (VC)</b>	1-3	2 (6.4V)

The Tekin QuickTune system provides access to a few basic adjustments on your ESC. All the settings in section 12 are available and semi-adjustable through this onboard system, with more options and higher resolution of settings available through the HotWire software with on PC or a mobile device. Making trackside adjustments takes just a few seconds!

## THROTTLE PROFILES

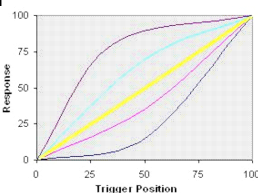

\*Accessible via HotWire\*

- 1) Mildest profile - concave
- 2) Mild profile - concave
- 3) Linear profile (DEFAULT)
- 4) Aggressive profile - convex
- 5) Most Aggressive profile - convex

Throttle profiles are available through the HotWire software and allow you to tune the aggressiveness of your ESC. Default is set to Linear which gives you consistent feel from low throttle to full. Profiles 1 & 2 will soften the feel in the low to mid throttle range and Profiles 4 & 5 increase the low to mid throttle aggressiveness. You can also create and save custom profiles in the HotWire software.

Stock racers may like the more aggressive profiles as they can make the car feel more "punchy" and modified racers typically run linear or one of the mild profiles to take the edge off. Throttle Profiles will work along side Throttle Frequency, see section 15 for information on adjusting the frequencies.

## THROTTLE & BRAKE FREQUENCY

Throttle and Brake Frequency both change the feel of the ESC dramatically. By default they are set to:

**Throttle** - 6kHz (2-12kHz range)

**Brake** - 6kHz (750hz-12kHz range)

**THROTTLE FREQUENCY:** Throttle Frequency changes the pulse width being applied during throttle application. In general higher frequencies provide a softer throttle power/feel with a more usable range of trigger motion allowing for better throttle modulation while keeping full throttle power overall. Lower frequency gives stronger throttle with a stronger overall feel.

**Modified Racing:** 6kHz and up

**Stock Racing:** 5kHz and down

**BRAKE FREQUENCY:** Brake Frequency changes the pulse width being applied during braking. In general higher frequencies provide a softer brake power/feel with a more usable range of trigger motion allowing for better brake modulation while keeping full brake power overall. Lower frequency gives stronger brakes with a stronger overall feel.

**Modified Racing:** 6-10kHz

**Stock Racing:** 6-10kHz

## TROUBLESHOOTING

**HINT:** When powered on, the ESC emits an all-systems-go chime if it is connected correctly to the motor and radio. Check Section 8 on reverse side if any codes are displayed.

### NO LIGHTS COME ON

- ◆ Check battery charge and polarity.
- ◆ Verify that the switch is in the ON position.
- ◆ Check all solder joints and plugs for a good connection.
- ◆ Unplug your servo from your receiver. A shorted servo can cause power up issues.
- ◆ Unplug sensor harness, possible sensor board short.
- ◆ Check ESC receiver plug for proper polarity.
- ◆ Re-flash ESC with HotWire. Incomplete or interrupted updates can "brick" the ESC.

### ALL LEDES FLASHING

- ◆ Check that transmitter and receiver are properly bound.
- ◆ Check ESC receiver plug for correct polarity and that it is plugged into CH2.

### WILL NOT CALIBRATE

- ◆ Check transmitter batteries and replace if necessary.
- ◆ Reverse throttle channel on transmitter if necessary.
- ◆ Check that transmitter and receiver are properly bound.

### NO STEERING OR THROTTLE

- ◆ Check battery voltage and polarity.
- ◆ Check that transmitter and receiver are properly bound.
- ◆ Check receiver plugs for correct polarity or damaged wires.

### STEERING WORKS, NO THROTTLE

- ◆ Check for Low Voltage Cutoff code (section 8).
- ◆ Check battery voltage.
- ◆ Check motor connections, try another motor if possible.
- ◆ Check ESC plug for correct polarity and damaged wires.

### THROTTLE WORKS, NO STEERING

- ◆ Shorted or broken servo.
- ◆ Check servo plug for correct polarity and damaged wires.
- ◆ Replace servo.

### MOTOR RUNS BACKWARDS

- ◆ Check transmitter throttle reverse setting.
- ◆ Verify motor wires are connected A - A, B - B and C - C. Wiring improperly while running a sensored motor with the sensor harness will damage the ESC.
- ◆ Reverse Motor may be checked in the HotWire.

### MOTOR RUNS WITH NO THROTTLE INPUT

- ◆ Set transmitter throttle trim to 0. If anything other than 0 is needed, perform a radio calibration with the trim at 0.

### LEDS 1, 2, 6 & 7 FLASHING

- ◆ Wrong Motor Type Selected.
- ◆ Internal ESC or Motor Short Detected.
- ◆ Try a different brushless motor.

### NO REVERSE

- ◆ Motor Type set to MT1 (no reverse).
- ◆ Motor Type set to MT3 (reverse delay). Needs 1 full second in neutral before reverse will activate.

### NO BRAKES

- ◆ Check transmitter Low Throttle EPA adjustments.
- ◆ Check Brake Strength settings in the ESC.
- ◆ Check for proper radio calibration. All LEDs should flash at full throttle and full brakes/reverse.

## ADJUST DRAG BRAKE VIA RADIO

Drag Brake strength can be adjusted on the fly via a spare channel on your radio. The included HotWire Adapter (TT3825) allows you to adjust the Drag Brake from a 3-position switch on your radio. **NOTE:** Not all radios will have the proper switch and settings to use this feature.

For a full explanation and help setting this feature up, please visit [www.teamtekin.com/adjustabledragbrake.html](http://www.teamtekin.com/adjustabledragbrake.html)

**STEP 1.** Connect your ESC to your receiver with the Adapter Cable.

**STEP 2.** Set your desired default Drag Brake Strength in the HotWire or with the buttons on the ESC.

**STEP 3.** Set up your radio so a 3-position switch talks to the spare channel your ESC AUX wire is now plugged into. This process will differ from radio to radio, so it is best to consult your user manual for radio programming.

### ACTIVE DRAG

Active Drag is a Drag Brake enhancement. Normal Drag Brake only activates when the ESC is in neutral and you are not applying any brake or throttle. Active Drag applies Drag Brake all the time, increasing the drag feel of the drivetrain and slows the vehicle down as you roll off throttle.

### FACTORY RESET

All Tekin ESCs have a built-in factory reset mode that resets all user programmable settings to the default values. To activate, turn the ESC on, then press/hold both the INCR and MODE buttons simultaneously for 3-5 seconds. The LEDs will ramp up in sets of three, confirming Factory Reset **NOTE:** Performing a Factory Reset also resets all the radio calibration settings to their default values. A radio calibration will need to be done.

### DATALOGGING MEMORY GAUGE

You can check the memory usage of the Datalogging feature by pressing and releasing the INCR button once. 1LED means no data has been recorded and all 7LEDs means memory is full. To reset and erase the data log memory, press and hold the INCR button. The ESC will chime and flash before going back to neutral. The HotWire is needed to open and view data logs (Section 20).

### REMOTE DATA ERASE

If checked in the HotWire, you can press and hold full brake for 3-5 seconds to clear your data log memory. This is very handy for logging a run if you don't want your warm up laps to take up data space on the ESC. **NOTE:** Make sure you're set to a Forward Only motor type to perform this action.

### D2 & SENSORED OPERATION

The RS GEN3 speed control is capable of running all brushless motors in sensorless mode, whether or not they have a sensor harness. The RS GEN3 will auto-detect any sensors and if present will operate in Dual Drive mode as standard. If no sensors are detected, the RS GEN3 will run sensorless. Tekin's D2 Dual Drive technology allows the ESC to start in sensored mode and switch to sensorless mode at higher RPMs for efficiency. This is a great feature for modified racing. Dual Drive and sensorless use the Timing Advance function, while running in Sensored-Only utilize the Boost and Turbo functions. The RS GEN3 is a very versatile piece of equipment as it has the capability to run brushless motors with sensors and without, as well as brushed motors.

### CHECKING SENSOR OPERATION

With Tekin ESCs you can quickly verify your ESC and sensored motor are communicating properly with the onboard sensor checker feature. Simply observe the right three LEDs (5, 6 & 7) with the ESC powered on and rotate the motor shaft slowly. If the sensor cable is plugged in and the sensors are operating correctly, you should see the three LEDs rotate through as each sensor is activated. This indicates that all sensors are functioning properly. Should a sensor go bad or the cable become disconnected while driving, the RS GEN3 will automatically default to sensorless drive mode, allowing you to finish the race.

## HOTWIRE™ 3.0 PROGRAMMING DEVICE

The HotWire 3.0 PC/Bluetooth Interface (TT1452) unlocks the full potential of your Tekin ESC. Connect via Bluetooth to your iOS or Android device for full adjustability of your ESC settings on the fly.

Offering a wide range of adjustable features and options, you can fully customize your setup to any particular track and any driving conditions. The HotWire can also be used to download Tekin Driver setups from the website and load them directly into your ESC. The HotWire makes it easy to load custom setups and save your own for any track and any car. Setup notes can be applied and saved with each user-created ESC profile so you can have the exact same setup you had before.

Tekin frequently releases new firmware for ESCs, which can be downloaded from the website and flashed to the ESC. This means a longer lifespan for your ESC! With access to tons of features not fully accessible from the onboard interface, the HotWire is a must have item. User-defined Throttle and Brake Frequency, Custom Throttle Profiles, Custom Voltage Cutoffs, Custom Boost and Turbo settings, adjustable RPM Ranges for Boost and Turbo, a new Datalogging feature and a programmable HV BEC can all be tuned via the HotWire Bluetooth on PC and handheld devices.

Check out more at [www.teamtekin.com/hotwire.html](http://www.teamtekin.com/hotwire.html)

## PARTS & ACCESSORIES

### CASE KITS

TT3851 - RS GEN3 Case Kit Black

TT3853 - RS GEN3 SPEC Case Kit Black

### CAPACITORS

TT3520 - Power Cap 16V 330uf

TT3522 - Power Cap 16V 1000uf (For low turn modified)

### SENSOR WIRES

TT3835 - FlatWire Sensor Cable 100mm

TT3836 - FlatWire Sensor Cable 150mm

TT3837 - FlatWire Sensor Cable 200mm

TT3838 - FlexWire Sleeved Sensor Cable 100mm

TT3839 - FlexWire Sleeved Sensor Cable 150mm

TT3840 - FlexWire Sleeved Sensor Cable 200mm

TT3841 - FlexWire Sleeved Sensor Cable 275mm

### HOTWIRE

TT1451 - HotWire 2.0

TT1452 - HotWire 3.0 BLE

## WARRANTY / REPAIR

**TEKIN, INC.** guarantees ESCs to be free from factory defects in materials and workmanship for a period of 180 days from date of purchase, when verified by sales receipt. This warranty does not cover: suitability for specific application, components worn by use or improper voltage, tampering, misuse, or shipping. Our warranty liability shall be limited to repairing unit to our original specifications. Because we have no control over the installation or use of this product, in no case shall we be liable for damages. Additionally, these items void the warranty:

- 1) Using the same polarity connectors on the battery and motor wires from the ESC.
- 2) Allowing water or moisture into the ESC.
- 3) Failure to attach the supplied capacitor.
- 4) Incorrect wiring or use inconsistent with the instructions.

**WARRANTY SERVICE:** For warranty work, you MUST CLAIM WARRANTY on A COMPLETELY FILLED OUT PRODUCT SERVICE FORM and include a VALID CASH REGISTER RECEIPT with purchase date, dealer name & phone# on it, or an invoice from previous service. If warranty provisions have been voided, there will be service charges.

**REPAIR:** Before sending your speed control in for service, please review the Instructions and Troubleshooting sections. After reviewing these instructions, if your speed control still requires service, please contact our customer service department for additional assistance.

**NOTE:** Hobby dealers and distributors are not authorized to replace TEKIN products thought to be defective.

Tekin, Inc.  
McCall, Idaho  
(208) 634-5559  
[www.teamtekin.com](http://www.teamtekin.com)